



Installation Guide

For HyPanel



Smarter Home
Sweeter Life

Welcome!

This guide applies to PS51-D1-EU model of HyPanel.

Contents

| | |
|---------------------------|----|
| Before We Start | 2 |
| In the Box | 3 |
| Check Compatibility | 4 |
| Wiring | 7 |
| Installation | 12 |
| Get Help | 16 |

Before We Start

Your first time installing this product may take up to 40 minutes.

You'll get faster after each installation.



Warning!

The installation procedure involves handling high voltage wiring. Please be careful. To avoid serious personal injury, death, or property damage, turn OFF the power to the circuit and follow all safety precautions before proceeding.

Working with electricity can be dangerous. If you are unsure about, or uncomfortable with the installation, seek the help of a qualified electrician.



Warning!

Keep the device and all its parts out of the reach of children. The small parts or accessories contained may be a choking hazard to them.

In The Box

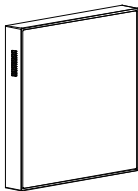

HyPanel X 1



ST3x20mm Phillips Self Tapping
Screw x2

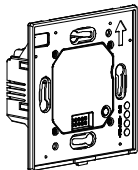

Flush Mounted Module x 1

Check Compatibility

Product specifications (mm)

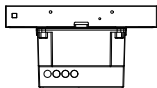

⑤ BOTTOM VIEW

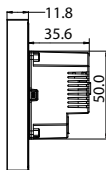

② RIGHT VIEW

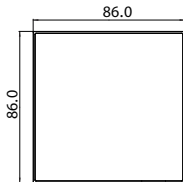

① FRONT VIEW

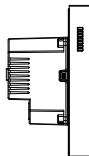

③ LEFT VIEW

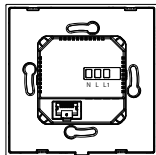

④ BACK VIEW

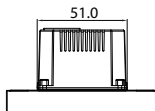

⑥ TOP VIEW

Working space

Make sure HyPanel is compatible with the location where you want to install it.

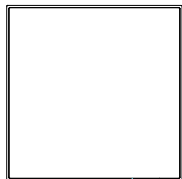

① HYPANEL FRONT VIEW

1100-1600mm TO BOTTOM OF PANEL

ADA Compliance Requirement

GROUND

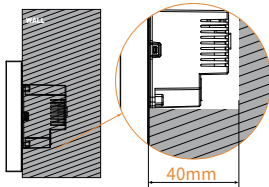
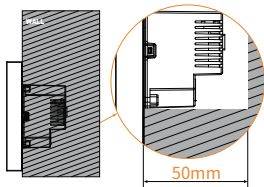

② SIDE VIEW:HYPANEL IN WALL

A 50mm(2 inches) deep electrical box is highly recommended for ease of installation. In some scenarios, especially when the wires can be pushed back into the wall far enough, it may be possible to use a 40mm(1.6 inches) deep box.

Maximum load

- ◆ The **total load** of the device(s) connected to HyPanel must be less than 300W(**Max load**).
- ◆ The wattage of a resistive load appliance, e.g., an incandescent bulb, must be less than 300W.
- ◆ The wattage of a LED lamp a compact fluorescent lamp (CFL) must be less than 150W.
- ◆ You must check the load compatibility before connecting other types of devices that are not mentioned above.

180~260VAC, 50 Hz power required

HyPanel can be used in countries with varying standard voltages, from 180V to 260V AC, at a frequency of 50Hz.

Neutral wire required for installation

A neutral wire is required for the device to function properly.

Support Wi-Fi and Ethernet connections

HyPanel can operate with both wireless and wired networks, but we highly recommend using wired networks if you want to remotely control the device via the BelaHome app or perform updates.

Wiring



Warning!

Turn OFF the circuit breaker before wiring and proceeding!
Always use a voltage detector to verify the power is OFF
before wiring and installation!

Identify wires

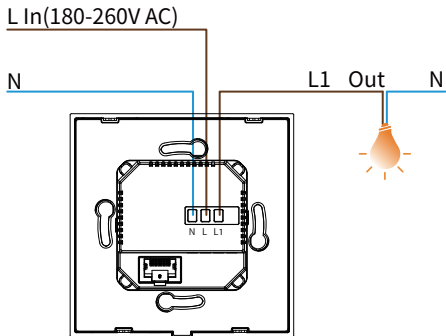

- ♦ A Neutral wire(N) typically comes from the wall.
- ♦ The Line wire(L) provides 180-260 Volts of power to the HyPanel.
- ♦ The Load wire (L1) carries power out to a single-channel dimmer.

Connect wires

1 Strip and straighten wires

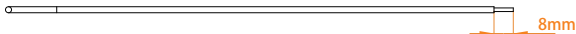

Wires connected to HyPanel should be $1.5\text{mm}^2 \sim 2.5\text{mm}^2$ in size and have stripped and straight ends.

Remove the plastic sheathing of the wire, and make sure the exposed wire ends measure approximately 8 mm (5/16 inch) in length.

2 Connect all wires

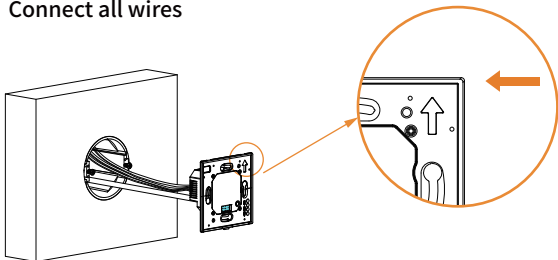

Always make sure the arrow on the front of the flush mounted module is pointing up.

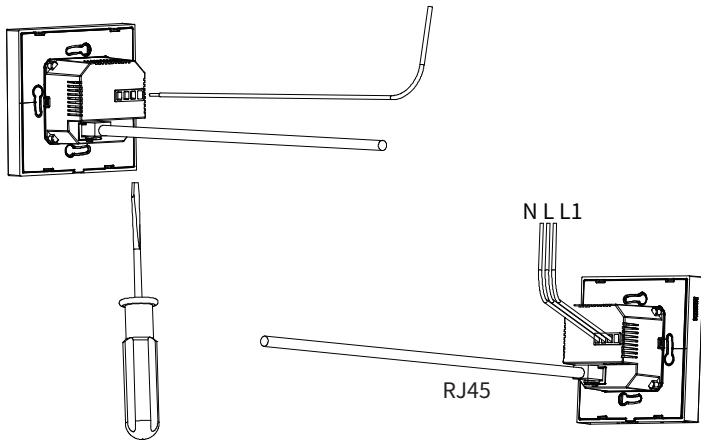

- Plug the wires to the corresponding ports on the back of the flush mounted module.
- Tighten the screws at the bottom clockwise with a flat-head screwdriver until wires are secure.
- Double check by gently tugging on each wire.
- Plug the RJ45 network cable to the Ethernet port if you need to use the wired network.

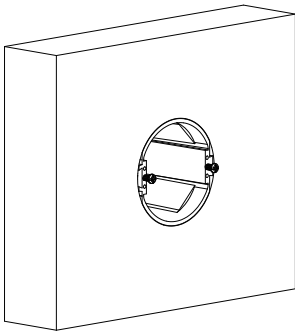

- Select proper screws fitting your electrical box.
- Change the torque on the electric screwdriver to 5kgf.cm.
- Turn screws clockwise with the screwdriver.
- Do not fully tighten the screws. The screw head must protrude at least 3 mm (1/8 inch) from the wall surface.

Installation

1 Install flush mounted module

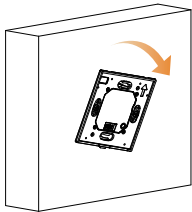

Attach the flush mounted module to the electrical box. The screws should go through the holes on the module.

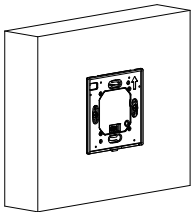

- Adjust the module to be level and ensure it is flush against the wall.
- Tighten the screws to attach the module to the wall, taking care not to over-tighten them.

2 Test connected devices

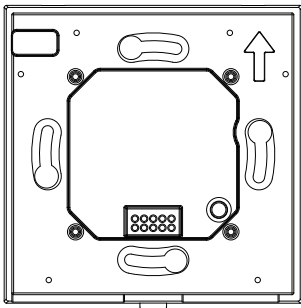

- ◆ Turn on the circuit breaker to provide power to the flush mounted module.
- ◆ Press the button on the module to check if the connected devices can work.

If the devices do not turn on/off, do NOT install the panel. Turn the power off and re-check the wire connections.

3 Install panel

Warning



Turn OFF the circuit breaker before you install the panel.

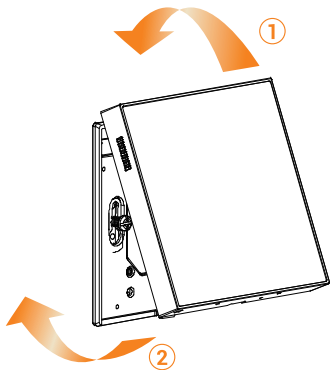

- ◆ Position the panel at a tilt as the picture shows.
- ◆ Press the panel into the flush mounted module until it clicks.

If you need to remove the panel

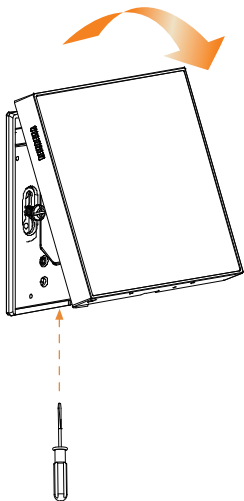

- ◆ Insert a flat-head screwdriver with about 6mm width into the slot at the bottom edge.
- ◆ Gently pry the panel up.

Congratulations!

You are done with the HyPanel installation!

Start your smart home journey with Akubela now!

Get Help

For help or more assistance,
contact us at: <https://ticket.akuvox.com/>

For videos, guides, and additional product formation,
visit us at: <https://knowledge.akuvox.com>



YS00000493